



Process Media

Place for your notes



Our Products

- Circular Vibrators
- Trough Vibrators
- Drying Systems
- Centrifuges for Process Water Treatment
- Separating Systems
- Special Mechanical Engineering
- Process media (grinding media, compounds, grinding additive)
- Other Equipment



Are you looking for innovative solutions for surface treatment and process water treatment? We offer a wide range of systems that are exactly right for your application. We, Eurotec Innovation GmbH, challenge ourselves every day to redefine the limits of what is feasible.

The "Eurotec Innovation" brand is a guarantee for high-quality products in the field of vibratory finishing and process water technology. All of our systems impress with their modular design, which means that they can be adapted according to customer requirements.



RF Circular Vibrator



ZS-M EUR Centrifuge



TV Trough Vibrator

Innovation – Made in Germany

Consumables Abrasive Media



- Different shapes available
- Individually adapted to your process
- High grinding performance with a long service life
- Granules for efficient drying of your components

Abrasive media are available in different sizes and geometries. Choose from a wide range of consumables a process medium that is ideally suited to your machining process. The selection is based on the composition of the workpiece and the desired effect on the surface. From rough grinding to polishing, a multitude of processing goals is possible. Liquid additives (compounds) are just as important for a high-quality vibratory finishing process as the drying of the component at the end.

In order to achieve the optimal finish for your surface, we would be happy to advise you personally and carry out free sample processing of your components in our technical center. We would be happy to support you in optimizing your processes!

Abrasive Media:

- Ceramic Media
- Plastic Media
- Granules for drying
- Special Media for polishing and high gloss sealing

**100% coordinated to your
machining process**

Guide for Process Media

Media	Shape	Due to its shape, the abrasive media must reach all contours (especially corners, edges and holes) of the workpiece and should not jam. Angular media shapes tend to have a more aggressive grinding behavior than round shapes.
	Size	With increasing size and weight of the abrasive the grinding performance increases. The grinding pattern becomes rougher.
	Material	Plastic and ceramic media are often used, but special media made from steel, wood or glass are also used for specific applications.
	Quality	The quality of the grinding performance has a significant influence on the grinding process and the grinding pattern. The grinding performance ranges from A (very abrasive) to P (polishing).
	Separation	In order to enable economical separation, there should be a sufficient difference in size between the workpiece and the abrasive media. With normal separation, the abrasive media is smaller than the workpiece, so it is discharged through a sieve. In special cases, a reverse separation, magnet separation or an individual concept can be used.
Compound	Type	Liquid additives (compounds) are usually used to support the vibratory finishing process. Powdered additives and pastes are added in individual cases depending on the requirement and goal.
	Purpose	Compounds support the removal of grinding abrasion from the vibratory finishing container via the liquid that is added during the grinding process. They optimize the vibratory finishing process, increase the abrasiveness, chemically clean and polish the material surface.
	Selection	In addition to the area of application, selection criteria for compounds include the material to be processed, the desired processing result and the compound properties: <ul style="list-style-type: none"> • Corrosion protection • Brightening • Degreasing and Cleaning • Recyclability (e.g. with Centrifuges)
Additives	Defoamer	Can be used in the case of heavy foaming in the circulatory system to reduce foaming.
	Adhesion prevention	To reduce the attachment (adhesion) of components.
	Grinding additive	Addition during the machining process to specifically influence the grinding result.

Article Number Key

All abrasive medias are provided with an individual article code in order to clearly identify them.

Example Designation: **KE-D13x13E S25**

KE	D	13x13	E	S25
KE	D	13x13	E	Packing size (e.g. bag 25 kg)
				Quality / Grinding performance
		13x13	Size (13x13 mm)	
	D	Shape (D=Triangle)		
KE	Material (KE-Ceramic)			

Quality / Grinding performance

The grinding performance has a significant influence on the grinding process and the grinding pattern. The qualities range from A (very abrasive) to P (polishing). In addition to the quality, the media size also influences the grinding performance.

With quality P, the grinding wheel is made of pure porcelain (Ceramic), which can serve as a carrier for grinding pastes or other additives. The abrasive media itself has no abrasion.



Depending on the media shape and size, several grinding stages are available.

Quality	A	B	C	D	E	F	G	H	I	J	K	L	M	N	O	P
	Very abrasive															
				Medium abrasive												
										Fine abrasive						
																Polishing

Plastic Media (KU)

Plastic media enable gentle and splinter-free vibratory grinding of sensitive materials (aluminum, brass, copper, zinc, magnesium, general die-cast materials). They are generally used for deburring and polishing ferrous and non-ferrous materials. The low weight and the soft binders prevent the burr from being rolled onto the material.

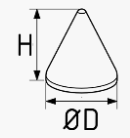
Depending on the quality, plastic media can produce light and matt surfaces and ensure a fine finish.

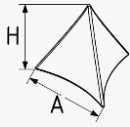
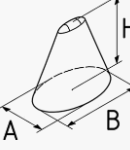
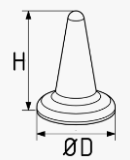



Shape			Size
Cone	K		6; 8; 10; 12; 15; 18; 20; 25; 30; 35; 40; 50; 60 Dimension: H = ØD
Tetrahedron	T		6; 8; 10; 12; 15; 20; 25; 30; 40; 45; 50; 60; 70; 80; 90 Dimension: H = A
Tetrahedron trident	TD		20; 25; 30; 40; 60 Dimension: H = A
Paraboloid	P		16x10x16; 29x17x30; 38x35x20; 50x50x30; 80x40x70 Dimension: A x B x H
Nipple	N		40x50; 50x60 Dimension: ØD x H
Further dimensions available on request			



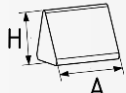
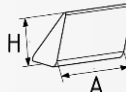
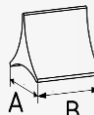

Ceramic Media (KE)

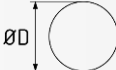
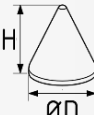
Ceramic media enable the workpieces to be processed effectively and evenly. They free the workpieces from unwanted material and burr inclusions. They are characterized by their longevity, good price-performance ratio, high density and the removal of strong burrs. In addition, high temperatures in the working container have no effect on the grinding performance.

Ceramic media offer a high level of surface finish on metal surfaces. Depending on the quality, they can deburr matt or create bright, shiny surfaces and are particularly suitable for harder materials such as steel or stainless steel.

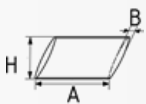
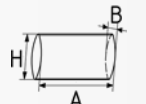
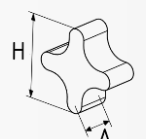
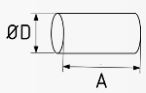
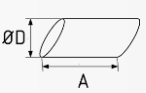
Shape			Size
Triangle	D		2x2; 4x4; 6x6; 8x8; 10x10; 13x13; 15x15; 20x20; 25x25; 30x30; 35x35; 40x40; 50x50 Dimension: H x A
Triangle angle cut	DS		2x2; 4x4; 4x8; 6x6; 6x12; 8x8; 10x10; 10x20; 12x12; 15x15; 15x18; 20x20; 25x25; 30x25; 30x30; 50x30; 50x50; 60x30 Dimension: H x A
Triangle tridnet	DD		4x4; 6x6; 8x8; 10x10; 12x12; 15x7; 15x15; 15x18; 22x22; 30x15; 30x25 Dimension: A x B
Triangle trident angle cut	DDS		4x4; 6x6; 8x8; 10x10; 12x12; 15x15; 15x18; 20x20; 30x25 Dimension: A x B
Ball	B		2; 3; 4; 5; 8; 10; 12; 14; 18; 20; 25 Dimension: ØD
Cone	K		10; 15; 20; 25; 30; 35; 40; 45; 50; 60 Dimension: ØD (H = D)
Tetrahedron (three-sided)	T		10; 15; 20; 25; 30; 35; 38; 40; 45; 60 Dimension: A (H = A)
Pyramid (four-sided)	TQ		6; 10; 15; 20; 40 Dimension: A (H = A)

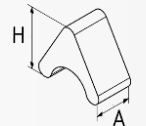
Shape		Size	
Ellipse angle cut	ES		8x3x8; 10x5x10; 15x7x15; 25x15x25 Dimension: A x B x H
Ellipse	E		8x3x8; 10x5x10; 15x7x15; 15x15x15; 25x15x25 Dimension: A x B x H
Star	S		10x10; 20x10; 20x20; 25x20; 30x15; 30x30; 45x15 Dimension: H x A
Cylinder	Z		3x6; 3x10; 4x6; 4x10; 5x10; 8x16; 12x12; 14x20; 15x17; 15x30; 15x40; 25x25 Dimension: ØD x A
Cylinder angle cut	ZS		2x5; 3x10; 5x10; 8x16; 14x20; 15x20; 15x30; 15x36; 15x40 Dimension: ØD x A
Cylinder double angle cut	ZSD		10; 12; 15; 18; 25 Dimension: ØD
Arrow	PF		<i>On request</i> Dimension: A x H



Drying and Polishing Media

Corn granules are particularly suitable for spot-free drying and light polishing in heated rotary dryers. Moisture and adhering abrasion from the grinding process is absorbed by the granules. In addition, corn granule is suitable for the effective removal of oil residues, such as stamping oils.

Nut granules are the ideal carrier for polishing pastes and are therefore suitable for fine polishing and cleaning of components for a high-quality finish.

The natural ingredients are responsible for an absolutely compatible and gentle drying of the workpieces.

Corn granules		Nut granules	
Type	Typical grain size (specification in mm)	Type	Typical grain size (specification in mm)
M06	3,80 – 5,00	N06	4,00 – 6,00
M08*	2,80 – 3,80	N08*	2,70 – 4,00
M12	1,80 – 2,80	N12	1,70 – 2,40
M16*	0,80 – 1,80	N16*	1,40 – 1,70
M20	0,50 – 1,20	N20	1,00 – 1,70
M30*	0,40 – 0,80	N30	0,45 – 1,00
M40	0,20 – 0,60	N40	0,45 – 0,75
M80	0,15 – 0,50	N80*	0,20 – 0,45

* Common and usually in stock



Wood (H)

Wood is relatively gentle and causes only minor wear and tear on the workpieces. Impregnated with polishing paste, they ensure a beautiful and even surface. Wood can also be used as a desiccant.

The natural ingredients are responsible for an absolutely compatible and gentle drying of the workpieces.

Hardwood (beech = B) is characterized by longevity and a good price-performance ratio. The high density allows the use of polishing agents and grinding additives. Hardwood is gentler than ceramic or steel media, making it ideal for delicate surfaces.

Softwood (spruce = F) is very absorbent and well suited for de-oiling and drying. Depending on the application, softwood can also be mixed with corn granules.

Article number key for wooden media

Example Designation: **H-Q13x13B S25**

H	Q	13x13	B	S25
H	Q	13x13	B	Packing size (e.g. bag 25 kg)
				B = Beech F = Spruce
			Size (13x13 mm)	
H	Q	Shape (Q=Cuboid)		
	Material (H-Wood)			

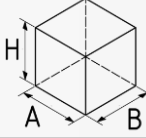
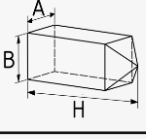
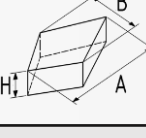
Shape			Size
Cube	Q		4x4x4; 4x4x10; 10x10x10 Dimension: A x B x H
Pen	ST		<i>On request</i> Dimension: A x B x H
Rhombus	R		10x5x5; 20x7x6; 25x9x8 Dimension: A x B x H
Further dimensions available on request			

Wood Granulate				
Type	Typical grain size (Specification in mm)		Type	Typical grain size (Specification in mm)
H06	3,00 – 5,00		H20	0,50 – 1,20
H08	2,00 – 4,00		H30	0,20 – 1,00
H12	1,00 – 3,00		H40	0,15 – 0,60
H16	0,50 – 2,00		H80	0,10 – 0,50



Liquid Compound (CF)

Liquid additives absorb the resulting abrasion and removal during the vibratory finishing process with water and support the removal.

The cleaning, passivation and brightening properties can be influenced by different additives in the compound.

Designation	Description of characteristics
CF122	Acidic compound especially for processing non-ferrous metals.
CF223	For processing aluminum, stainless steel and zinc alloys with brightening additives.
CF648	Universal recirculation compound with high cleaning performance and corrosion protection.
CF654	Universal recirculation compound for processing ferrous and non-ferrous metals with corrosion protection.
CF774	Universal recirculation compound for processing ferrous and non-ferrous metals. With increased corrosion protection and additives for brightening.
CF784	Recirculation compound for processing ferrous and non-ferrous metals. With corrosion protection and additives for brightening.
CF887	Especially for steel components with high corrosion protection.
CF909	Especially for processing plastic components.

	Steel / Iron	Stainless steel	Aluminum	Copper	Zinc	Brass	Plastic		Deburring	Coarse and fine grinding	Smooth / Shine	Polishing	Cleaning	Degreasing	Descaling		pH-Value (1%)
CF122		X															1,5
CF223		X	X		X				X	X	X	X		X			3,0
CF648	X	X		X	X	X			X	X	X	X		X			8,0
CF654	X	X							X	X							7,8
CF774	X	X							X	X							8,2
CF784	X																9,7
CF887	X																10,0
CF909							X						X				11,3

Compound Powder (CP)

Powdery compounds are valuable helpers in the vibratory finishing process. They not only increase the grinding performance, but also support the degreasing and cleaning of the workpieces. Under certain conditions, they can also be used for polishing.

Flocculant

Flocculants are an important tool to improve the effectiveness of cleaning performance and grinding performance. They are added to bind and sediment fine grinding particles and abrasion products. They improve the discharge of fats, oils, metal debris and solids in centrifuges.

Designation	pH-Value	Description of characteristics
FF10	3,0	Universally applicable liquid Flocculant.
FF20	3,5	Universally applicable liquid Flocculant.
FP50	6,0	Powdered Flocculant for process water purification.
FP60	9,5	Powdered Flocculant for process water purification.



Liquid Compound



Compound Powder

Grinding and Polishing Paste (PA)

Grinding and polishing pastes are common tools that are often used in flow technology. They ensure a flawless, high-gloss surface and enhance the polishing effect.

Dry polishing pastes, on the other hand, are used in combination with a carrier medium. Due to their gentle effect, they are particularly suitable for sensitive surfaces and enable a fine, smooth final polish.

Adhesion Release Balls (ATK)

Adhesive separating balls prevent flat workpieces from sticking (e.g. washers, sheet metal components). The separating balls are available as glass beads (G), acrylic glass beads (AG) or plastic beads (KU). The separating balls are filtered out together with the process liquid and the abrasion by a waste water treatment plant (e.g. centrifuge).

Steel Media (S)

Stainless steel balls and satellites are ideal for pressure deburring and mirror polishing. Due to the high density, special vibratory finishing systems (ball polishing version) are usually necessary.

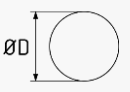
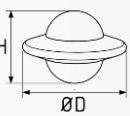
Shape			Size
Ball	B		1,5; 2; 2,5; 4; 6 Dimension: ØD
Satellite	SAT		3x5; 5x7; 7x10 Dimension: H x ØD
Further dimensions available on request.			



EUROTEC **INNOVATION**

Vibratory Finishing Technology
Process Water Technology
Grinding Technology
Abrasives
Edge Rounding
Special Mechanical Engineering

Your contact person in sales:

Eurotec Innovation GmbH
Industriestraße 36
89349 Burtenbach
Germany

Tel.: +49 (0)8285 20098-0
info@eurotec-innovation.com
www.eurotec-innovation.com



No liability is assumed for errors and misprints. Technical changes reserved. Reprinting is prohibited. Illustration may contain optional accessories, which are available at extra cost. All dimensions and performance information without guarantee.

DV001 V1.1-EN

